

Guidelines for
Traffic Control
in Work Zones

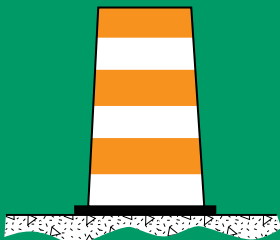

OHIO DEPARTMENT OF
TRANSPORTATION

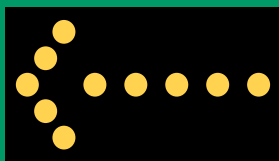

April 2012

Guidelines for Traffic Control in Work Zones

Table of Contents

Introduction	1
Major Traffic Control Considerations	2
Fundamental Principles.....	3
Components of Temporary Traffic Control Zones.....	4
Definitions.....	5
Tapers.....	6
Flagging	7-11
Arrow Boards.....	11-12
Channelizing Devices	12-13
Warning Lights	14
Nighttime Operations.....	14-15
Signs	15-17
Summary of Layout Dimensions.....	17
Typical Application Diagrams	18-48
Flagger's Checklist.....	49
Supervisor's Checklist	50
Typical Application Matrix	51-53

Introduction

The primary function of temporary traffic control is to provide for the reasonably safe and efficient movement of road users through or around temporary traffic control zones while reasonably protecting workers, responders to traffic incidents, and equipment. Concurrent objectives of the temporary traffic control are the efficient construction and maintenance of the highway and the efficient resolution of traffic incidents.

Part 6 of the Ohio Manual of Uniform Traffic Control Devices (OMUTCD) is Ohio's standard for all traffic control devices used during construction, maintenance, and utility activities as well as incident management. This handbook summarizes some guidelines listed in the OMUTCD. It is directed to state and local government road and street departments, utilities, companies performing construction by permit, and any other entity providing maintenance or construction on a public roadway. It contains basic principles, a description of the standard traffic control devices used in work areas, guidelines for the application of the devices, and typical application diagrams. This handbook gives the basic principles and provides examples for the design, application, installation, and maintenance of the various types of traffic control devices used in temporary traffic control or for incident management. This information is intended to provide the principles of proper work zone traffic control, but is not a standard. **Part 6 of the OMUTCD contains the standards for work zone traffic control.**

The application diagrams shown represent common applications for typical situations. They are not intended as substitutes for engineering judgment and should be altered to fit the conditions of a particular site – keeping in mind that all traffic control devices used must be in compliance with Part 6 of the OMUTCD.

To obtain a copy of the current OMUTCD, contact ODOT's Office of Traffic Engineering (614-466-3601) or Office of Contracts (1-800-459-3778).

Major Traffic Control Considerations

Every work zone situation is different so several items must be considered in determining the traffic control needed. Following is a list of some questions that illustrate the major traffic control considerations.

1. What will be the time duration of the work?
 - Long-term stationary – Work that occupies a location more than three days.
 - Intermediate-term stationary – Work that occupies a location more than one daylight period up to three days, or nighttime work lasting more than one hour.
 - Short-term stationary – Daytime work that occupies a location for more than one hour, within a single daylight period.
 - Short duration – Work that occupies a location up to one hour.
 - Mobile – Work that moves intermittently or continuously.
2. Where is the work zone located (on the roadway, on the shoulder, or beyond the shoulder)?
3. What type of road is involved?
4. What is the speed of the traffic?
5. What is the traffic volume on the roadway? Should the work be rescheduled to avoid heavy volume conditions?
6. Will the nature of traffic change while work is underway?
7. Will the work impact pedestrians and/or bicycle facilities?
8. Do the local law enforcement agencies need to be notified?
9. What kind of signing will be required?
10. Are cones, drums, barricades, or an arrow panel needed for traffic channelization?
11. Will a flagger be required?

Fundamental Principles

The control of road users through a temporary traffic control zone shall be an essential part of highway construction, utility work, maintenance operations, and incident management. The following principles provide guidance to assist road users and help protect workers in the vicinity of temporary traffic control zones.

1. Road user and worker safety in temporary traffic control zones should be an integral and high priority element of every project from planning through design and construction.
2. General plans or guidelines should be developed to provide safety for drivers, bicyclists, pedestrians, workers, enforcement/emergency officials, and equipment.
3. Road user movement should be inhibited as little as practical.
4. Motorists, bicyclists, and pedestrians should be guided in a clear and positive manner while approaching and traversing temporary traffic control zones and incident sites.
5. Routine day and night inspections of temporary traffic control elements should be performed.
6. Attention should be given to the maintenance of roadside safety during the life of the temporary traffic control zone.
7. Each person whose actions affect temporary traffic control zone safety should receive training appropriate to the job decisions each individual is required to make.
8. Good public relations should be maintained.
9. All temporary traffic control devices shall be removed as soon as practical when they are no longer needed.

Components of Temporary Traffic Control Zones

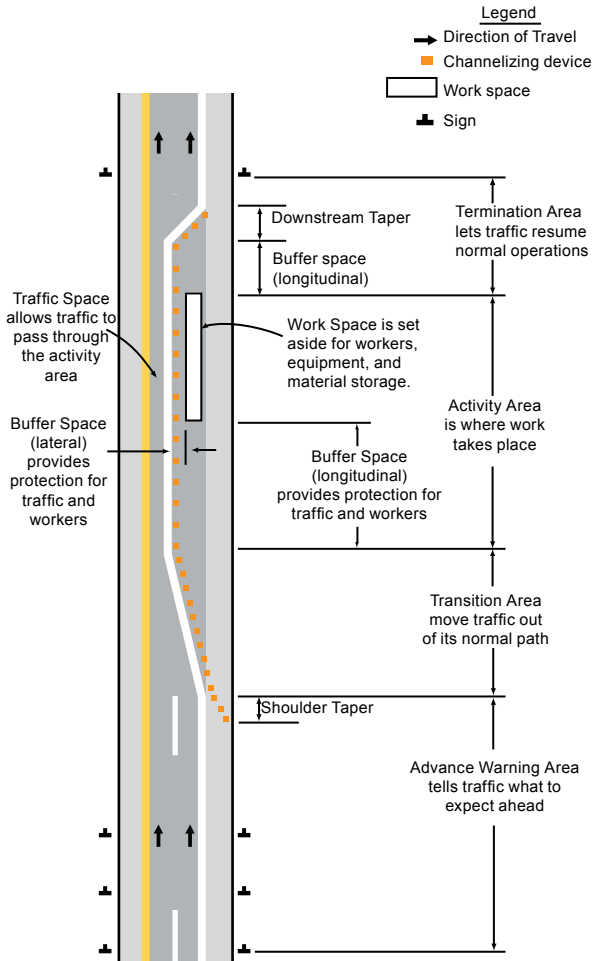

Definitions

Rural Highway

A type of roadway normally characterized by lower volumes, higher speeds, fewer turning conflicts, and less conflicts with pedestrians.

Urban Street

A type of street normally characterized by relatively low speeds, wide ranges of traffic volumes, narrower lanes, frequent intersections and driveways, significant pedestrian traffic, and more businesses and houses.

Other Terms

Some terms used commonly in discussing temporary traffic control applications are not specifically defined in Part 6 of the OMUTCD. Therefore, as part of the traffic control planning process, each agency should review Part 6 (and other appropriate sources, if needed) to determine generally how it will define the terms “low speed”, “high speed”, “low volume”, and “high volume” for streets and highways under its jurisdiction.

For example, page 17 of this handbook includes the OMUTCD table “Suggested Advance Warning Sign Spacing”, which indicates that the speed category (Urban low speed or high speed) is to be determined by the highway agency.

The term “low volume road(s)” is used in the typical applications on pages 27, 29 and 31 of this handbook. Since Part 6 of the OMUTCD does not provide a specific definition of the term, each agency is responsible for addressing how these applications are used, if at all, on its system of streets and highways.

Tapers

Merging Taper

A merging taper requires the longest distance because drivers are required to merge into common road space. A merging taper should be long enough to enable merging drivers to have adequate advance warning and sufficient length to adjust their speeds and merge into an adjacent lane before the downstream end of the transition.

Following is a table of merging taper lengths (L) and the maximum spacing of channelizing devices for various speeds and widths of closing.

Taper Length*

Speed Limit (mph)	Lane Width (Feet)			Max. Spacing of Devices (Feet)
	10	11	12	
25	105	115	125	25
35	205	225	245	35
45	450	495	540	45
55	550	605	660	55
65	650	715	780	65

*Following are the formulas used to calculate taper length:

Posted Speed	Formula
40 mph or under	$L = WS^2/60$
45 mph or over	$L = WS$

where: L = taper length in feet; W = width of offset in feet; and S = posted speed limit, or off-peak 85th percentile speed prior to work starting, or the anticipated operating speed in mph.

Shifting Taper

A shifting taper is used when a lateral shift is needed. A shifting taper should be approximately L in length; however, it may be approximately 1/2 L when the speed is less than 50 mph.

Tapers (continued)

Shoulder Taper

A shoulder taper may be beneficial on a high-speed roadway where shoulders are part of the activity area and are closed, or when improved shoulders might be mistaken as a driving lane. If used, shoulder tapers should have a length of approximately 0.33 L.

Downstream Taper

If used, a downstream taper should have a minimum length of 50 feet and a maximum length of 100 feet with devices placed at a spacing of approximately 20 feet.

One-Lane, Two-Way Taper

A one-lane, two-way taper is used in advance of an activity area that occupies part of a two-way roadway in such a way that a portion of the road is used alternately by traffic in each direction. A one-lane, two-way taper should have a minimum length of 50 feet and a maximum length of 100 feet with channelizing devices at approximately 20-foot spacings.

Flagging

Flaggers

A flagger shall be a person who provides temporary traffic control. A flagger should be able to demonstrate the following abilities:

1. Ability to receive and communicate specific instructions.
2. Ability to move and maneuver quickly.
3. Ability to control signaling devices.
4. Ability to understand and apply safe traffic control practices.
5. Ability to recognize dangerous situations and warn coworkers.

Flagger Use

When a one-lane, two-way temporary traffic control zone is short enough to allow a flagger to see from one end of the zone to the other, traffic may be controlled by either a single flagger or by a flagger at each end of the section.

When a single flagger is used, the flagger should be stationed on the shoulder opposite the constriction or work space, or in a position where good visibility and traffic control can be maintained at all times.

High Visibility Clothing

For daytime and nighttime activity, flaggers shall wear high-visibility safety apparel that meets the Performance Class 2 or 3 requirements of the ANSI/ISEA 107-2004 publication entitled “American National Standard for High-Visibility Apparel and Headwear” and labeled as meeting the ANSI 107-2004 standard performance for Class 2 or 3 risk exposure. The apparel background (outer) material color shall be fluorescent orange-red, fluorescent yellow-green, or a combination of the two as defined in the ANSI standard. The retroreflective material shall be orange, yellow, white, silver, yellow-green, or a fluorescent version of these colors, and shall be visible at a minimum distance of 1000 feet. The retroreflective safety apparel shall be designed to clearly identify the wearer as a person.

Hand-Signaling Devices

The sign paddle bearing the message STOP or SLOW provides road users with more positive guidance than flags and should be the primary hand-signaling device.

The STOP/SLOW paddle shall have an octagonal shape on a rigid handle. STOP/SLOW paddles shall be at least 18 inches wide with letters at least 6 inches high. The STOP (R1-1) face shall have white letters and a white border on a red background. The SLOW (W20-8) face shall have black letters and a black border on an orange background. When used at night, the STOP/SLOW paddle shall be retroreflectorized.

Flags, when used, shall be red or fluorescent orange/red in color, a minimum of 24 inches square, and securely fastened to a staff that is approximately 36 inches in length.

The free edge of a flag should be weighted so the flag will hang vertically, even in heavy winds. When used at nighttime, flags shall be retroreflectorized red.

Flagger Stations

Flagger stations shall be located such that approaching road users will have sufficient distance to stop at an intended stopping point.

Guidelines for determining the distance of the flagger station in advance of the work space are shown in the table on page 17. The distances shown may be increased for downgrades and other conditions that affect stopping distance.

Except in emergency situations, flagger stations shall be preceded by advance warning signs. Except in emergency situations, flagger stations shall be illuminated at night.

The flagger should stand either on the shoulder adjacent to the road user being controlled or in the closed lane prior to stopping road users. A flagger should only stand in the lane being used by moving road users after road users have stopped. The flagger should be clearly visible to the first approaching road user at all times. The flagger also should be visible to other road users. The flagger should be stationed sufficiently in advance of the workers to warn them (for example, with audible warning devices such as horns or whistles) of approaching danger by out-of-control vehicles. The flagger should stand alone, away from other workers, work vehicles, or equipment.

At spot lane closures where adequate sight distance is available for the reasonably safe handling of traffic, the use of one flagger may be sufficient. The table on page 17 may be used to determine the visibility distance for road users approaching the flagger.

Flagging Procedures

The following methods of signaling with paddles shall be used:

1. **To stop road users**, the flagger shall face road users and aim the STOP paddle face toward road users in a stationary position with the arm extended horizontally away from the body. The free arm shall be held with the palm of the hand above shoulder level toward approaching traffic.



TO STOP TRAFFIC

2. **To direct stopped road users to proceed**, the flagger shall face road users with the SLOW paddle face aimed toward road users in a stationary position with the arm extended horizontally away from the body. The flagger shall motion with the free hand for road users to proceed.



TO LET TRAFFIC PROCEED

3. **To alert or slow traffic**, the flagger shall face road users with the SLOW paddle face aimed toward road users in a stationary position with the arm extended horizontally away from the body.



TO ALERT AND SLOW TRAFFIC

Communication

When two flaggers are used, they can communicate verbally or visually if they are close enough and visible to each other. One of the flaggers should be designated as the coordinator. Where the end of a one-lane section is not visible from the other end, the flaggers may maintain control using such methods as:

1. Radio or field telephone,
2. Flag transfer method where the driver of the last vehicle proceeding into the one-lane section is given a red flag (or other token) and instructed to deliver it to the flagger at the other end,
3. An official car that follows the last road user proceeding through the section, or
4. A pilot car to guide a queue of vehicles through the temporary traffic control zone or detour. The flag transfer or official car method should only be used for a maximum length of about one mile. The pilot car shall have a sign (G20-4) mounted on the rear of the vehicle.

Arrow Boards

An arrow board shall be a sign with a matrix of elements capable of either flashing or sequential displays. This sign shall provide additional warning and directional information to assist in merging and controlling road users through or around a temporary traffic control zone. Arrow boards shall meet the minimum size, legibility distance, number of elements, and other specifications shown on Figure 6F-6. Arrow board elements shall be capable of at least a 50 percent dimming from full brilliance. The dimmed mode shall be used for nighttime operation of arrow boards. For shoulder work, blocking the shoulder, for roadside work near the shoulder, or for temporarily closing one lane on a two-lane, two-way roadway, an arrow board shall be used only in the

caution mode.

An arrow board should be used in combination with appropriate signs, channelizing devices, or other temporary traffic control devices. An arrow board should be placed on the shoulder of the roadway or, if practical, further from the traveled lane. It should be delineated with retroreflective temporary traffic control devices. When an arrow board is not being used, it should be removed; if not removed, it should be shielded; or if the previous two options are not feasible, it should be delineated with retroreflective temporary traffic control devices.

NOTE: Review and understand the full text of Section 6F.61 of the OMUTCD prior to implementing a traffic plan using Arrow Boards.

Channelizing Devices

The function of channelizing devices is to warn road users of conditions created by work activities in or near the roadway and to guide road users.

All channelizing devices shall be crashworthy. The spacing between cones, tubular markers, vertical panels, drums, and barricades should not exceed a distance in feet equal to 1.0 times the speed limit in mph when used for taper channelization, and a distance in feet 2.0 times the speed limit in mph when used for tangent channelization.

Devices that are damaged or have lost a significant amount of their retroreflectivity and effectiveness shall be replaced. See OMUTCD Part 6 for additional information.

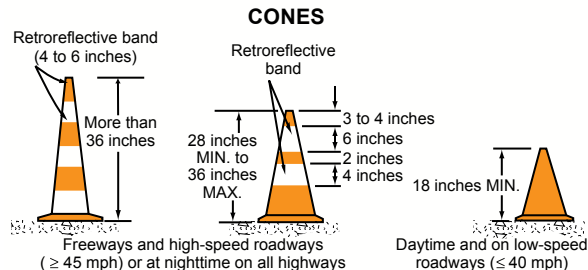

NOTE: Warning lights on Channelizing Devices are optional.

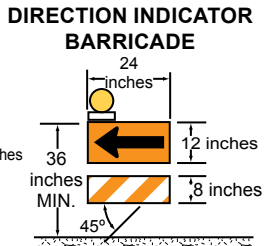
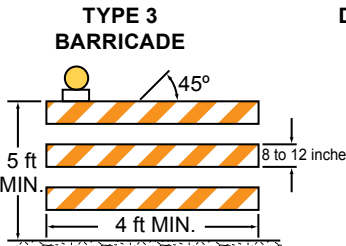
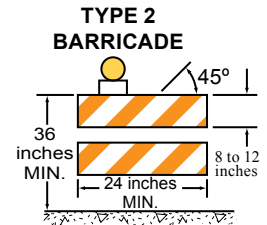
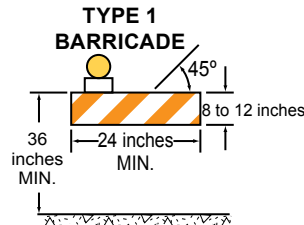
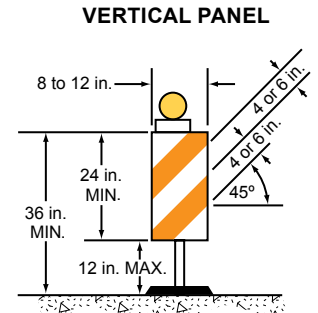
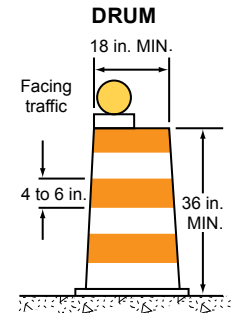
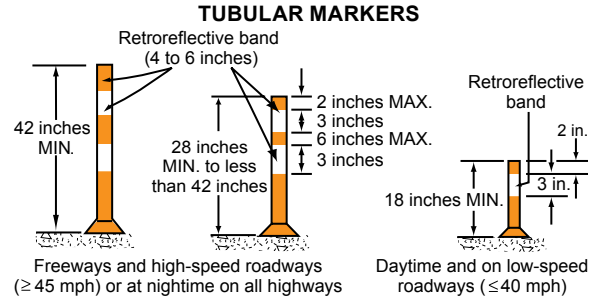

Warning Lights

Warning lights shall be in accordance with the current ITE “Purchase Specification for Flashing and Steady-Burn Warning Lights.” When warning lights are used, they shall be mounted on signs or channelizing devices in a manner that, if hit by an errant vehicle, they will not be likely to penetrate the windshield.

Type A Low-Intensity flashing warning lights are used to warn road users during nighttime hours that they are approaching or proceeding in a potentially hazardous area. Type A warning lights may be mounted on channelizing devices.

Type B High-Intensity flashing warning lights are used to warn road users during both daylight and nighttime hours that they are approaching a potentially hazardous area. Type B warning lights are designed to operate 24 hours per day and may be mounted on advance warning signs or on independent supports.

Type C Steady-Burn warning lights and Type D 360-degree Steady-Burn warning lights may be used during nighttime hours to delineate the edge of the traveled way. When used to delineate a curve, Type C and Type D 360-degree warning lights should only be used on devices on the outside of the curve, and not on the inside of the curve.

Nighttime Operations

All traffic control devices shall be retroreflectorized when used at night. Workers shall wear high-visibility safety apparel that meets the Performance Class 2 or 3 requirements of the ANSI/ISEA 107-2004 publication. Some employers require a higher performance class of apparel to be worn above the levels required by the national standard. Cones shall be equipped with reflective collars when used at night. When barricades are used, it is desirable to add flashing lights when the barricades are used singly and steady burn lights

when they are used in a series for channelization. If a flagger is used, the flagger stations shall be adequately illuminated.

Signs

Types

1. **Regulatory signs** inform road users of traffic laws or regulations and indicate the applicability of legal requirements that might not otherwise be apparent. Regulatory signs shall be authorized by the public agency or official having jurisdiction. They are generally rectangular with a black legend and border on a white background. Exceptions include the STOP, YIELD, DO NOT ENTER, WRONG WAY, and ONE WAY signs.
2. **Warning signs** in temporary traffic control zones notify road users of specific situations or conditions on or adjacent to a roadway that might not otherwise be apparent. Temporary traffic control warning signs shall be diamond-shaped with a black legend and border on an orange background, except for the Railroad Crossing sign which shall have a black legend and border on a yellow background, and except for signs that are required or recommended in Part 2 or 7 of the OMUTCD to have fluorescent yellow-green backgrounds.
3. **Guide signs** provide road users with information to help them along their way through the temporary traffic control zone. The design of guide signs is presented in Part 2 of the OMUTCD. The following guide signs should be used in temporary traffic control zones as needed: standard route markings (where temporary route changes are necessary), directional signs, street name signs, and special guide signs relating to the condition of work being done. If additional temporary guide signs are used in temporary traffic control zones, they shall have a black legend on an orange background.

For information on sign sizes, refer to OMUTCD Table 6F-1.

Sign Supports

Fixed sign supports should be used on long-term projects. Portable supports are more practical for intermediate and short-term projects. Following are illustrations of height and lateral locations of signs on fixed supports and methods of mounting other than on posts. Signs mounted on barricades or other supports may be at lower heights than on fixed supports but the bottom of the sign shall be no less than one foot above the traveled way.

Sign Placement

Signs should normally be located on the right-hand side of the roadway. Where special emphasis is needed, signs may be placed on both the left-hand and right-hand sides of the roadway. Neither portable nor permanent sign supports should be located on sidewalks, bicycle facilities, or areas designated for pedestrian or bicycle traffic. Signs mounted on portable supports should not be used for a duration of more than 3 days.

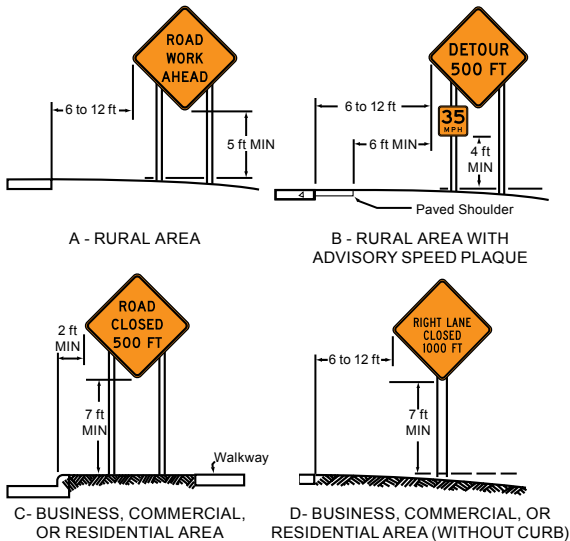

Advance Warning Area

The distance from the first sign to the start of the transition area should be long enough to give motorists adequate time to respond to the conditions. The tables below summarize layout dimensions as referenced in the typical application diagrams (see pages 18 – 48).

Summary of Layout Dimensions

Recommended Advance Warning Sign Minimum Spacing

Road Type	Distance Between Signs (in feet)		
	A	B	C
Urban (low speed)*	100'	100'	100'
Urban (high speed)*	350'	350'	350'
Rural	500'	500'	500'
Expressway/Freeway	1,000'	1,500'	2,640'

*Speed Category to be determined by the highway agency

Maximum Spacing of Channelizing Devices (in feet)

Road Type	Taper	Buffer/Work Space	Downstream
Two-lane	20'	2 x Speed Limit	20'
Multi-lane	Speed Limit	2 x Speed Limit	20'

Tapers and Flagger Station Distances (in feet)

Speed Limit (mph)	Two-Lane	Multi-Lane **			Flagger Station/ Buffer
	Max. Two-Way Taper *	Merging Taper 12' lane	Shifting Taper 12' lane	Shoulder Taper 10' shoulder	
20		80'	40'	25'	115'
25		125'	70'	35'	155'
30		180'	90'	50'	200'
35		245'	130'	70'	250'
40	50' MIN - 100' MAX	320'	160'	90'	305'
45		540'	280'	150'	360'
50		600'	600'	170'	425'
55		660'	660'	190'	495'
60		720'	720'	200'	570'
65		780'	780'	220'	645'

* Refers to a one-lane, two-way traffic taper (see pages 7 and 26).

** Multi-lane layouts use buffer zones instead of flagger stations

Note: If used, a downstream taper should be 50' MIN and 100' MAX

Typical Application Diagrams

The diagrams on the following pages represent examples of the application of principles and procedures for safe and efficient temporary traffic control in work zones. It is not possible to include illustrations to cover every situation which will require work area protection. They are not intended as a substitute for engineering judgment and should be be altered to fit the conditions of a particular site. All traffic control devices used must be in compliance with the OMUTCD. Guidelines for taper lengths are given. Refer to pages 6, 7 and 17 for more specific information on taper lengths. For further information, refer to Part 6 of the OMUTCD (using the "TA-" number listed on each layout to identify that illustration in the OMUTCD). A matrix showing setups applicable to typical activities can be found on the back cover of the booklet.

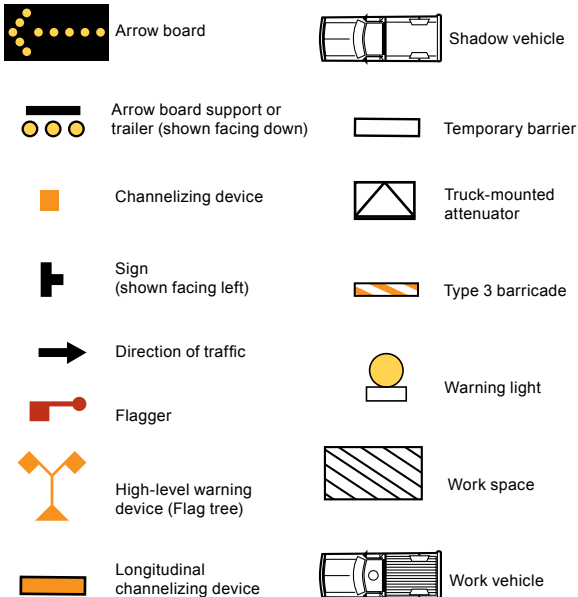

18

Work Beyond the Shoulder (TA-1)

If the work space is in the median of a divided highway, an advance warning sign should also be placed on the left side of the directional roadway.

The ROAD WORK AHEAD sign may be omitted where the work space is behind a barrier, more than 24 inches behind the curb, or 15 feet or more from the edge of any roadway. Although vehicle hazard warning signals may be used to supplement, they shall not be used instead of high-intensity rotating, flashing, oscillating, or strobe lights.

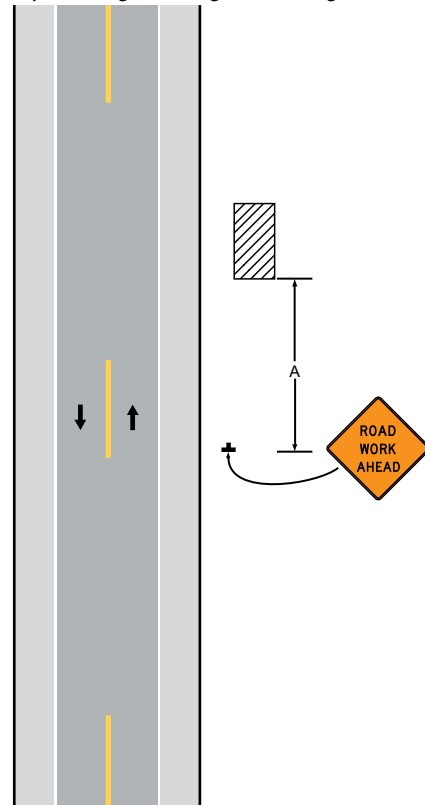

Note: For layout dimensions see page 17.

19

Work on the Shoulders (TA-3)

A SHOULDER WORK sign should be placed on the left side of the roadway for a divided or one-way street only if the left shoulder is affected.

Although vehicle hazard warning signals may be used to supplement, they shall not be used instead of high-intensity rotating, flashing, oscillating, or strobe lights.

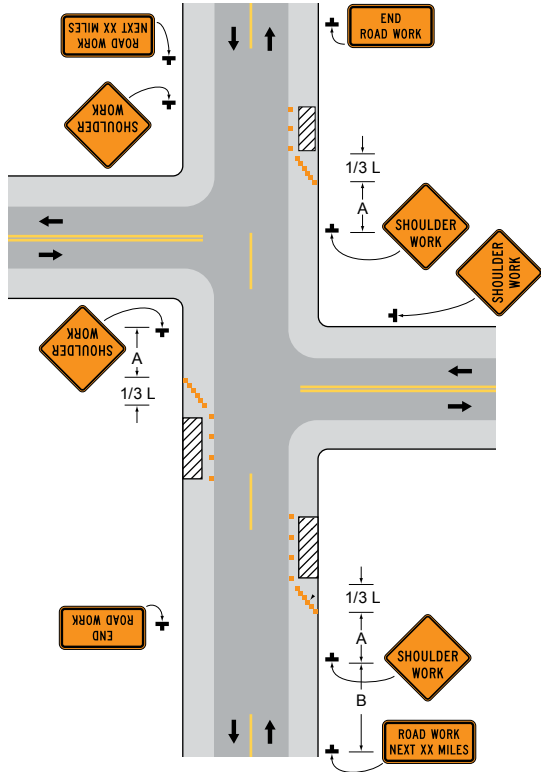

Note: For layout dimensions see page 17.

20

Short-Duration or Mobile Operation on a Shoulder (TA-4)

Although vehicle hazard warning signals may be used to supplement, they shall not be used instead of high-intensity rotating, flashing, oscillating, or strobe lights. If an arrow board is used for an operation on the shoulder, the caution mode shall be used.

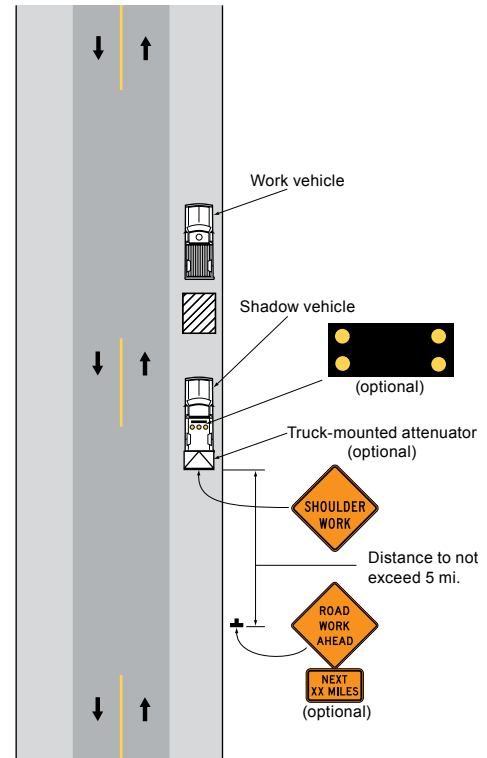

21

Shoulder Work with Minor Encroachment (TA-6)

All lanes should be a minimum of 10 feet in width as measured to the near face of the channelizing devices. The treatment shown should be used on a minor road having low speeds. For higher-speed traffic conditions, a lane closure should be used. Although vehicle hazard warning signals may be used to supplement, they shall not be used instead of high-intensity rotating, flashing, oscillating, or strobe lights.

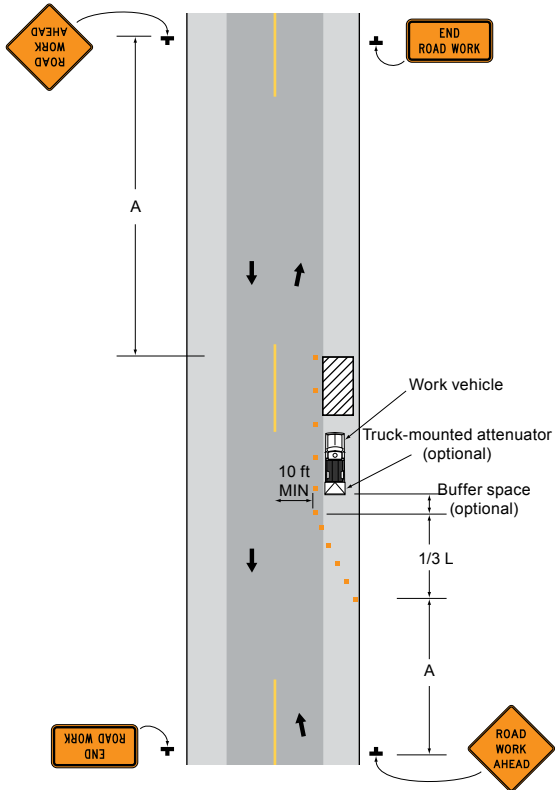

Note: For layout dimensions see page 17.

Road Closure with an Off-Site Detour (TA-8)

If the road is opened for some distance beyond the intersection and/or there are significant origin/destination points beyond the intersection, the ROAD CLOSED and DETOUR signs on Type 3 Barricades should be located at the edge of the traveled way.

If the road is closed a short distance beyond the intersection and there are few origin/destination points beyond the Type 3 Barricades shown in the figure may be moved to the center of the traveled lanes. Refer to OMUTCD Figure 6H-8 Note 4 for additional requirements.

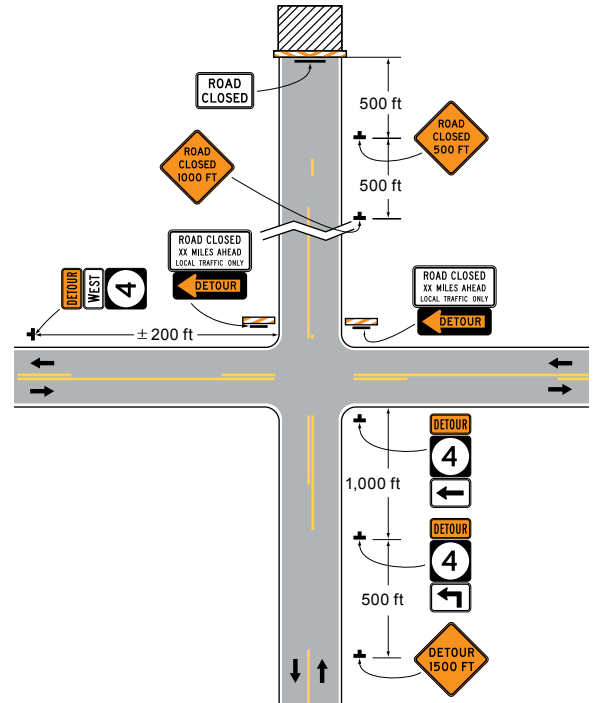

Overlapping Routes with a Detour (TA-9)

STOP or YIELD signs displayed to side roads should be installed as needed along the temporary route.

Flashing warning lights and/or flags may be used to call attention to the advance warning signs.

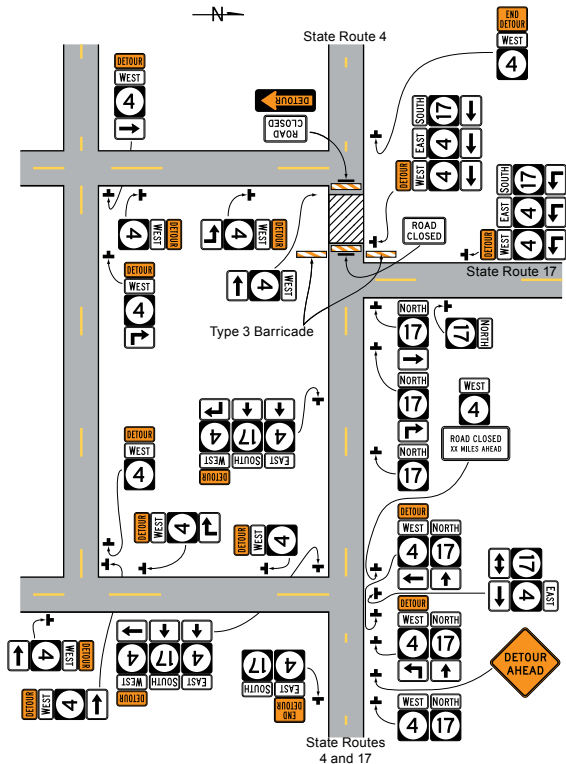

Note: Temporary traffic control devices are shown for one direction of travel only. Devices similar to those depicted shall be placed for the opposite direction of travel.

Lane Closure on a Two-Lane Road Using Flaggers (TA-10)

For low-volume situations with short work zones on straight roadways where the flagger is visible to road users approaching from both directions, a single flagger, positioned to be visible to road users approaching from both directions, may be used.

The ROAD WORK AHEAD and the END ROAD WORK signs may be omitted for short-duration operations.

Flashing warning lights and/or flags may be used to call attention to the advance warning signs. A BE PREPARED TO STOP sign may be added to the sign series.

The buffer space should be extended so that the two-way traffic taper is placed before a horizontal (or crest vertical) curve to provide adequate sight distance for the flagger and a queue of stopped vehicles. At night, flagger stations shall be illuminated, except in emergencies. When used, the BE PREPARED TO STOP sign should be located between the Flagger sign and the ONE LANE ROAD sign.

When a grade crossing exists within or upstream of the transition area and it is anticipated that queues resulting from the lane closure might extend through the grade crossing, the temporary traffic control zone should be extended so that the transition area precedes the grade crossing.

When a grade crossing equipped with active warning devices exists within the activity area, provisions should be made for keeping flaggers informed as to the activation status of these warning devices.

When a grade crossing exists within the activity area, drivers operating on the left-hand side of the normal center line should be provided with comparable warning devices as for drivers operating on the right-hand side of the normal center line.

Early coordination with the railroad company or light rail transit agency should occur before work starts.

(See Illustration on Next Page)

Lane Closure on a Two-Lane Road Using Flagger (TA-10)

A ROAD WORK AHEAD sign may be used in place of ROAD WORK XX MILE sign. A ONE LANE ROAD AHEAD sign may be used in place of the ONE LANE ROAD XX FT sign.

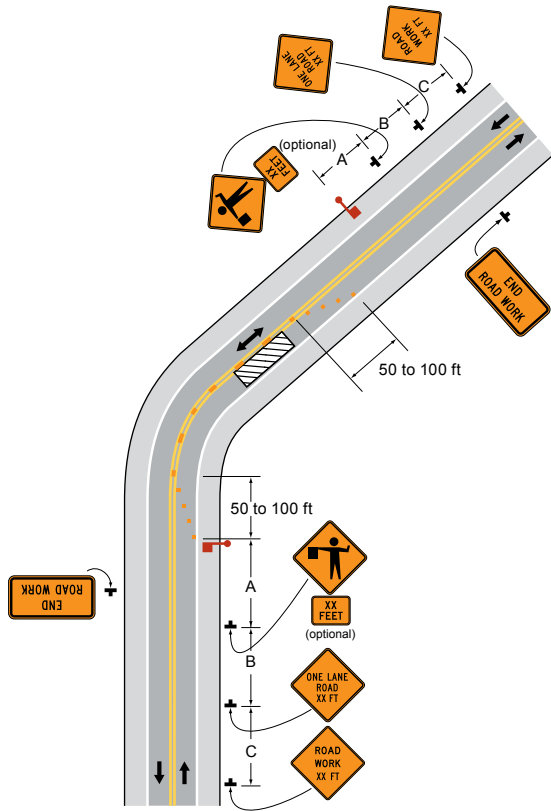

Note: For layout dimensions see page 17.

Lane Closure on a Two-Lane Road with Low Traffic Volumes (TA-11)

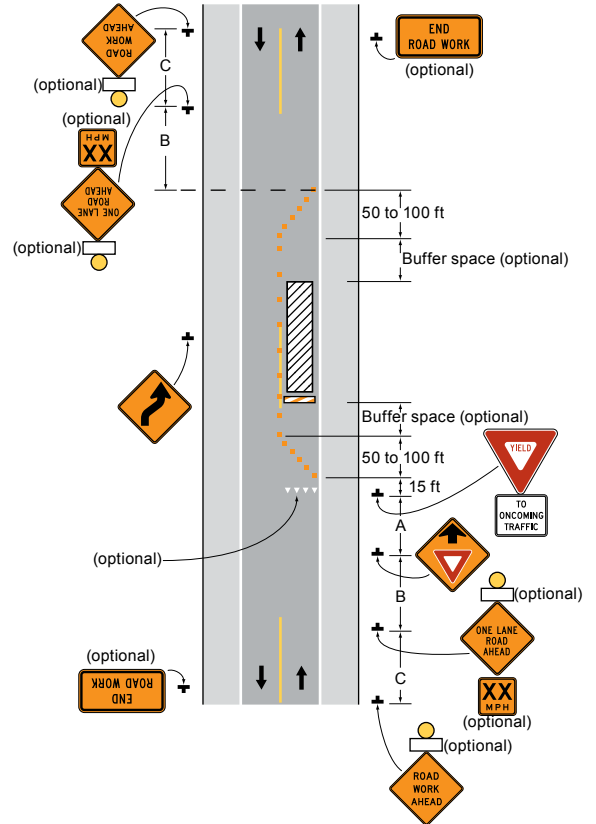

Note: For layout dimensions see page 17.

Temporary Road Closure (TA-13)

Conditions represented are a planned closure not exceeding 20 minutes during the daytime. A flagger or uniformed law enforcement officer shall be used for this application. The flagger shall follow the procedures provided in Sections 6E.07 and 6E.08 of the OMUTCD.

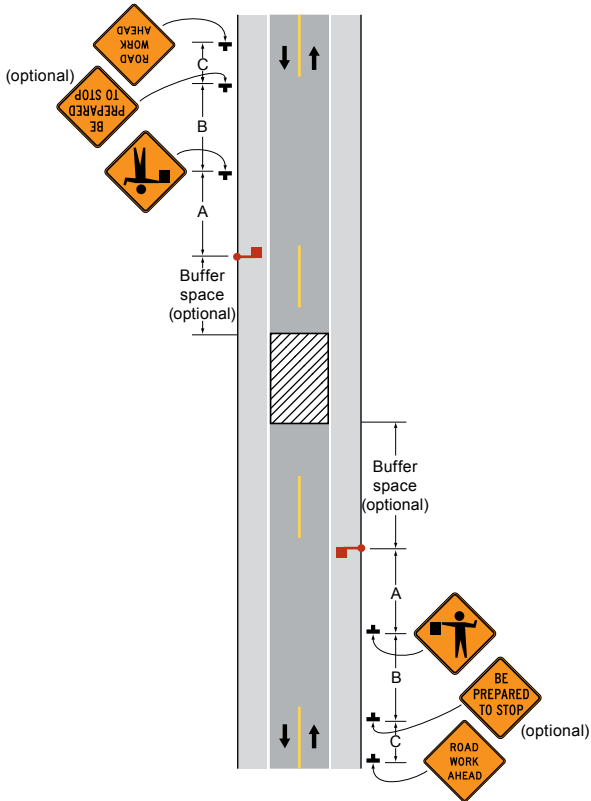

Note: For layout dimensions see page 17.
28

Work in the Center of a Road with Low Traffic Volumes (TA-15)

The lanes on either side of the center work space should have a minimum width of 10 feet as measured from the near edge of the channelizing devices to the edge of pavement or the outside edge of paved shoulder. Although vehicle hazard warning signals may be used to supplement, they shall not be used instead of high-intensity rotating, flashing, oscillating,

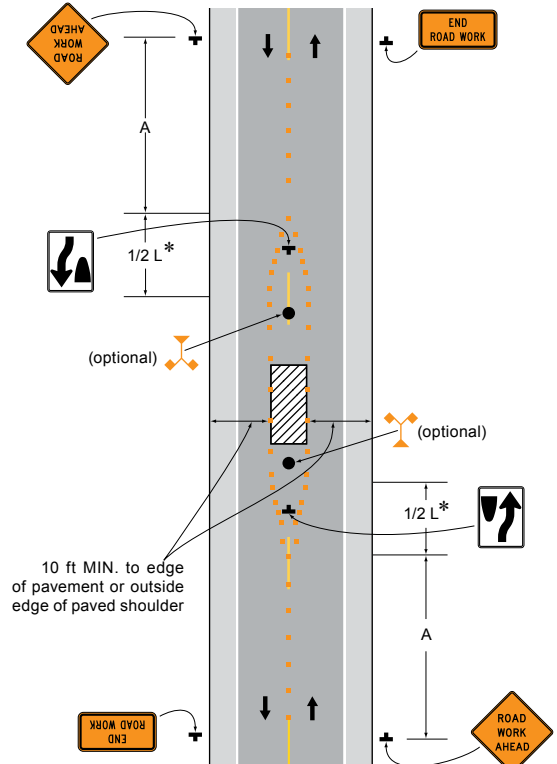

* Shift tapers should be L where speeds are 50 mph, or greater.

Note: For layout dimensions see page 17.
29

Mobile Operations on a Two-Lane Road (TA-17)

Vehicle-mounted signs shall be mounted in a manner such that they are not obscured by equipment or supplies. Sign legends on vehicle-mounted signs shall be covered or turned from view when work is not in progress. Shadow and work vehicles shall display high-intensity rotating, flashing, oscillating, or strobe lights. If an arrow board is used, it shall be used in the caution mode. Where practical and when needed, the work and shadow vehicles should pull over periodically to allow vehicular traffic to pass. Whenever adequate stopping sight distance exists to the rear, the shadow vehicle should maintain the minimum distance from the work vehicle and proceed at the same speed. The shadow vehicle should slow down in advance of vertical or horizontal curves that restrict sight distance. The shadow vehicles should also be equipped with two high-intensity flashing lights mounted on the rear, adjacent to the sign.

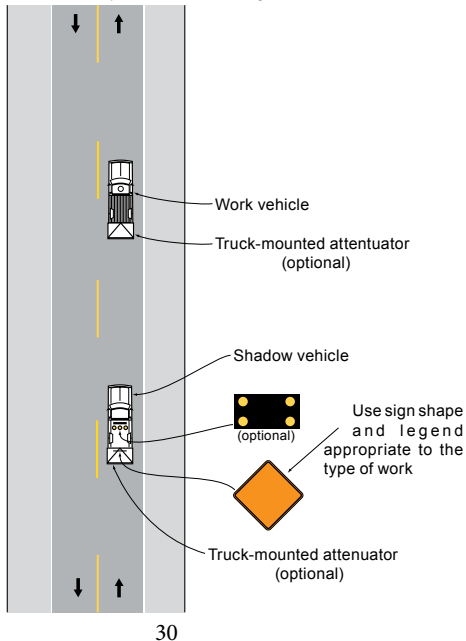

Lane Closure on a Minor Street (TA-18)

This temporary traffic control shall be used only for low-speed facilities having low traffic volumes. Where the work space is short, where road users can see the roadway beyond, and where volume is low, vehicular traffic may be self-regulating. Where vehicular traffic cannot effectively self-regulate, one or two flaggers shall be used as illustrated on TA-10. Flashing warning lights and/or flags may be used to call attention to the advance warning signs. A truck-mounted attenuator may be used on the work vehicle and the shadow vehicle.

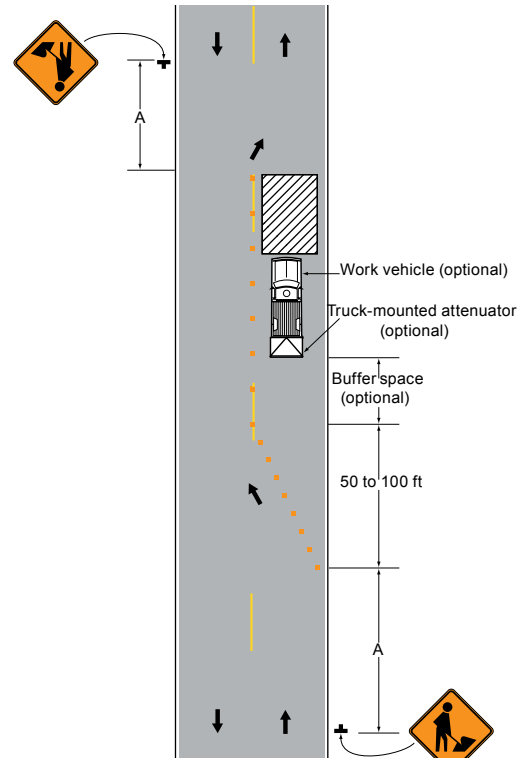

Note: For layout dimensions see page 17.

Detour for a Closed Street (TA-20)

This plan should be used for streets without posted route numbers.

Detour signs may be located on the far side of intersections. A Detour sign with an advance arrow may be used in advance of a turn.

A Street Name sign may be mounted with the Detour sign. The Street Name sign may be either white on green or black on orange. When used, the Street Name sign shall be placed above the Detour sign.

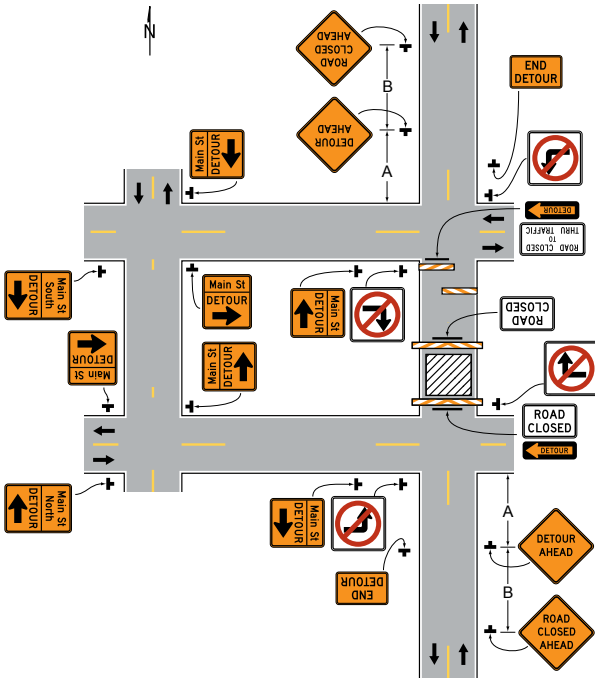

Note: For layout dimensions see page 17.

Right-Hand Lane Closure on the Far Side of an Intersection (TA-22)

If the work space extends across a crosswalk, the crosswalk should be closed.

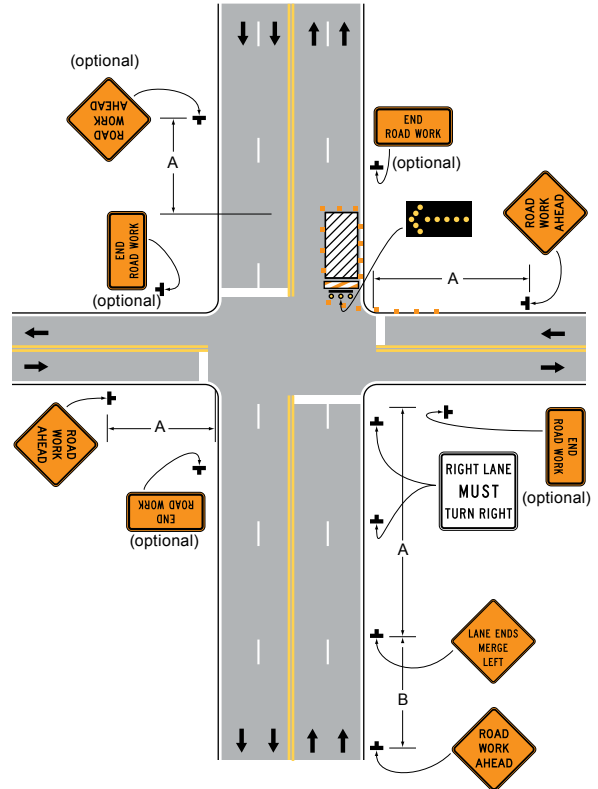

Note: For layout dimensions see page 17.

Sidewalk Detour or Diversion (TA-28)

When crosswalks or other pedestrian facilities are closed or relocated, temporary facilities shall be detectable and shall include accessibility features consistent with the features present in the existing pedestrian facility.

Where high speeds are anticipated, a temporary traffic barrier and, if necessary, a crash cushion should be used to separate the temporary sidewalks from vehicular traffic.

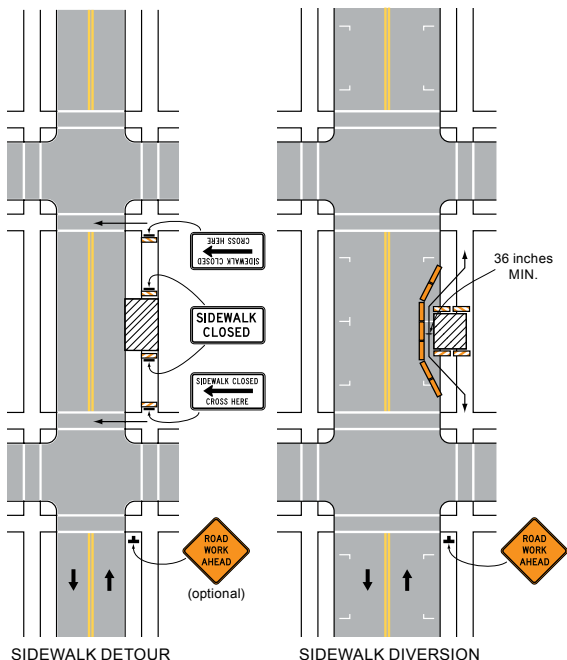

36

Interior Lane Closure on a Multi-lane Street (TA-30)

This information applies to low-speed, low-volume urban streets. Where speed or volume is higher, additional signing such as LANE ENDS (W4-2) should be used between the signs shown. When an additional sign is used, the signs shown shall be relocated to accommodate standard sign spacing for the added sign.

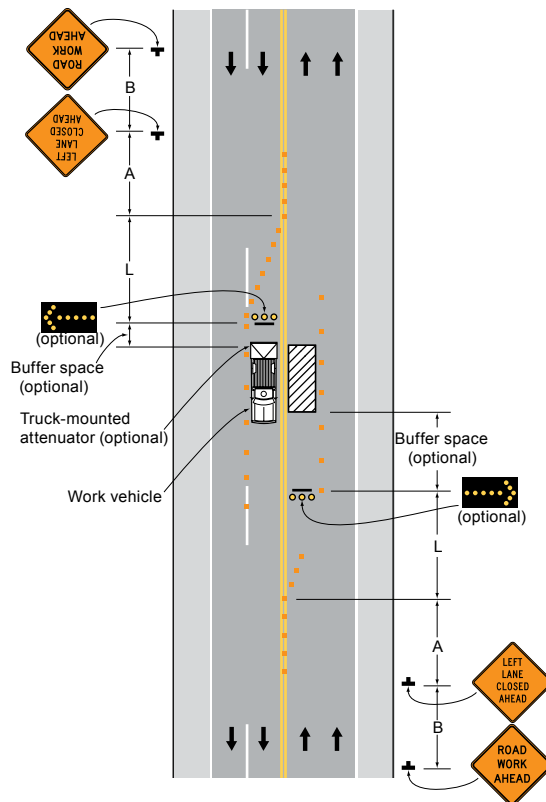

Note: For layout dimensions see page 17.

37

Stationary Lane Closure on a Divided Highway (Short Term) (TA-33)

This information also shall be used when work is being performed in the lane adjacent to the median on a divided highway. In this case, the LEFT LANE CLOSED signs and the corresponding Lane Ends signs shall be substituted. When a side road intersects the highway within the temporary traffic control zone, additional temporary traffic control devices shall be placed as needed.

A truck-mounted attenuator may be used on the work vehicle and/or shadow vehicle. Where conditions permit, restricting all vehicles, equipment, workers, and their activities to one side of the roadway might be advantageous.

An arrow board shall be used when a freeway lane is closed. When more than one freeway lane is closed, a separate arrow board shall be used for each closed lane.

A ROAD WORK AHEAD sign may be used in place of ROAD WORK XX MILE sign.

(See Illustration on Next Page)

Stationary Lane Closure on a Divided Highway (Short Term) (TA-33)

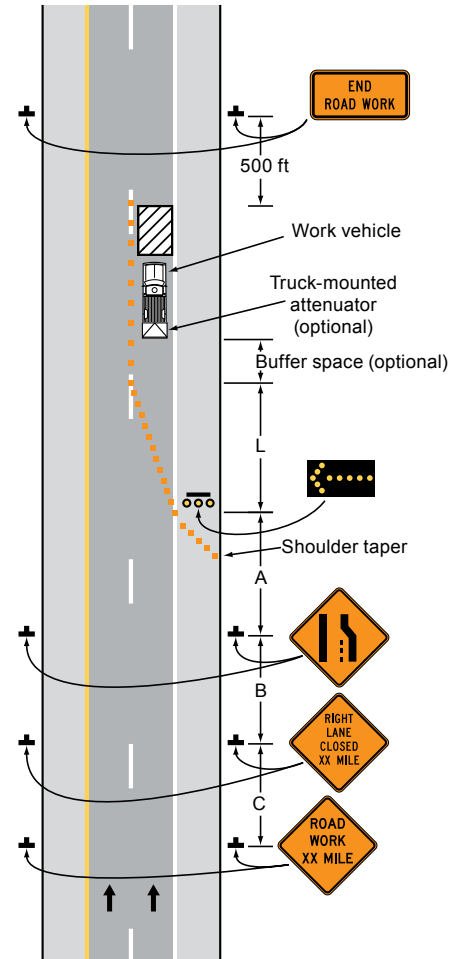

Note: For layout dimensions see page 17.

Mobile Operation on a Multi-lane Road (TA-35)

Arrow boards shall, as a minimum, be Type B, with a size of 60 x 30 inches. Vehicle-mounted signs shall be mounted in a manner such that they are not obscured by equipment or supplies. Sign legends on vehicle-mounted signs shall be covered or turned from view when work is not in progress.

Shadow and work vehicles shall display high-intensity rotating, flashing, oscillating, or strobe lights. An arrow board shall be used when a freeway lane is closed. When more than one freeway lane is closed, a separate arrow board shall be used for each closed lane.

Vehicles used for these operations should be made highly visible with appropriate equipment, such as flags, signs, or arrow boards. Shadow Vehicle 1 should be equipped with an arrow board and truck-mounted attenuator. Shadow Vehicle 2 should be equipped with an arrow board. An appropriate lane closure sign should be placed on Shadow Vehicle 2 so as not to obscure the arrow board. Shadow Vehicle 2 should travel at a varying distance from the work operation so as to provide adequate sight distance for vehicular traffic approaching from the rear. The spacing between the work vehicles and the shadow vehicles, and between each shadow vehicle should be minimized to deter road users from driving in between.

Work should normally be accomplished during off-peak hours. When the work vehicle occupies an interior lane (a lane other than the far right or far left) of a directional roadway having a right-hand shoulder 10 feet or more in width, Shadow Vehicle 2 should drive the right-hand shoulder with a sign indicating that work is taking place in the interior lane.

(See Illustration on Next Page)

Mobile Operation on a Multi-lane Road (TA-35)

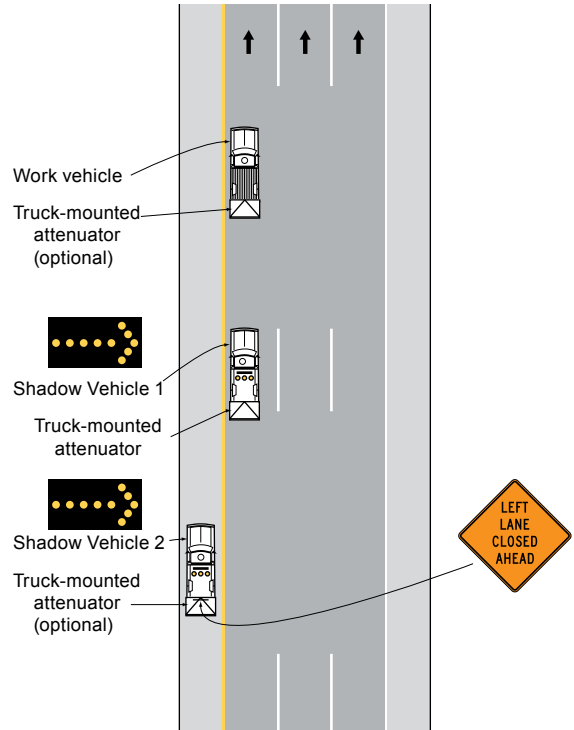

Double Lane Closure on a Freeway (TA-37)

An arrow board shall be used when a freeway lane is closed. When more than one freeway lane is closed, a separate arrow board shall be used for each closed lane.

Ordinarily, the preferred position for the second arrow board is in the closed exterior lane at the upstream end of the second merging taper. However, the second arrow board should be placed in the closed interior lane at the downstream end of the second merging taper in the following situations:

- When a shadow vehicle is used in the interior closed lane, and the second arrow board is mounted on the shadow vehicle;
- If alignment or other conditions create any confusion as to which lane is closed by the second arrow board; and
- When the first arrow board is placed in the closed exterior lane at the downstream end of the first merging taper (the alternative position when the shoulder is narrow).

When a shoulder lane is used that cannot adequately accommodate trucks, trucks should be directed to use the normal travel lanes.

A ROAD WORK AHEAD sign may be used in place of ROAD WORK 1 MILE sign.

(See Illustration on Next Page)

Double Lane Closure on a Freeway (TA-37)

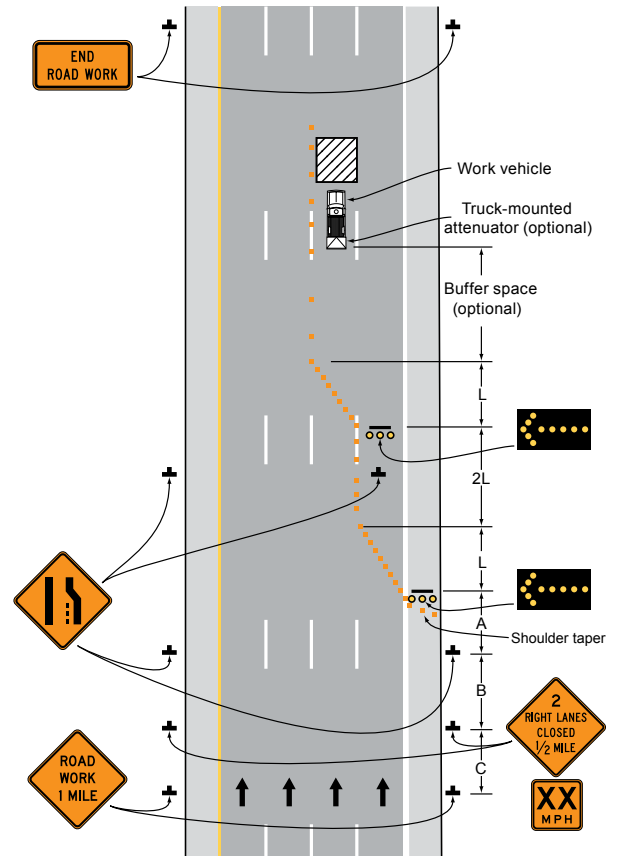

Note: For layout dimensions see page 17.

Work in the Vicinity of an Exit Ramp (TA-42)

The guide signs should indicate that the ramp is open, and where the temporary ramp is located. However, if the ramp is closed, guide signs should indicate that the ramp is closed.

A temporary EXIT sign shall be located in the temporary gore. For better visibility, it shall be mounted a minimum of 7 feet from the pavement surface to the bottom of the sign. An arrow board shall be used when a freeway lane is closed. When more than one freeway lane is closed, a separate arrow board shall be used for each closed lane.

An alternative procedure that may be used is to channelize exiting vehicular traffic onto the right shoulder and close the lane as necessary.

A ROAD WORK AHEAD sign may be used in place of ROAD WORK XX MILE sign. A RIGHT LANE CLOSED AHEAD sign may be used in place of the RIGHT LANE CLOSED XX MILE sign.

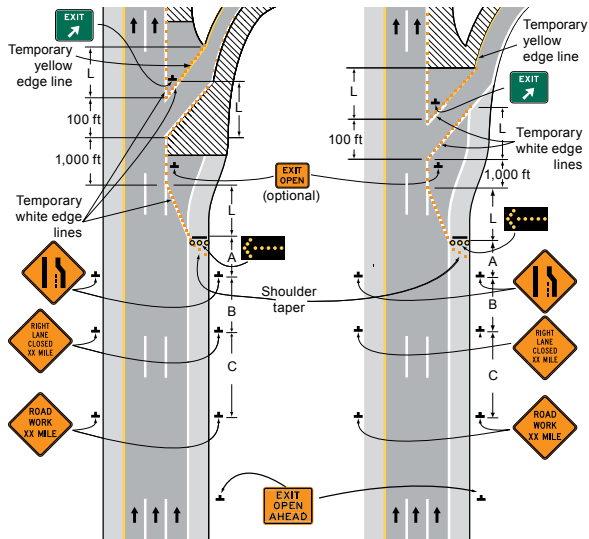

Note: For layout dimensions see page 17.

Work in the Vicinity of an Entrance Ramp (TA-44)

An acceleration lane of sufficient length should be provided whenever possible as shown on the left diagram on the following page.

For the information shown on the diagram on the right side of the typical application, where inadequate acceleration distance exists for the temporary entrance, the YIELD sign shall be replaced with STOP signs (one on each side of the approach).

When used, the YIELD or STOP sign should be located so that ramp vehicular traffic has adequate sight distance of oncoming mainline vehicular traffic to select an acceptable gap in the mainline vehicular traffic flow, but should not be located so far forward that motorists will be encouraged to stop in the path of the mainline traffic. Also, a longer acceleration lane should be provided beyond the sign to reduce the gap size needed. If insufficient gaps are available, consideration should be given to closing the ramp.

Where STOP signs are used, a temporary stop line should be placed across the ramp at the desired stop location.

An arrow board shall be used when a freeway lane is closed. When more than one freeway lane is closed, a separate arrow board shall be used for each closed lane.

A ROAD WORK AHEAD sign may be used in place of ROAD WORK XX MILE sign. A RIGHT LANE CLOSED AHEAD sign may be used in place of the RIGHT LANE CLOSED XX MILE sign.

(See Illustration on Next Page)

Work in the Vicinity of an Entrance Ramp (TA-44)

Work in the Vicinity of a Grade Crossing (TA-46)

When grade crossings exist either within or in the vicinity of roadway work activities, extra care should be taken to minimize the probability of conditions being created, by lane restrictions, flagging, or other operations, where vehicles might be stopped within the grade crossing, considered as being 15 ft on either side of the closest and farthest rail.

If the queuing of vehicles across active rail tracks cannot be avoided, a uniformed law enforcement officer or flagger shall be provided at the highway-rail grade crossing to prevent vehicles from stopping within the grade crossing (as described above), even if automatic warning devices are in place.

The DO NOT STOP ON TRACKS sign should be used on all approaches to a highway-rail grade crossing within the limits of a TTC zone.

When used, the BE PREPARED TO STOP sign should be located before the Flagger symbol sign.

A ROAD WORK AHEAD sign may be used in place of ROAD WORK XX MILE sign. A ONE LANE ROAD AHEAD sign may be used in place of the ONE LANE ROAD XX FT sign.

At night, flagger stations shall be illuminated, except in emergencies.

(See Illustration on Next Page)

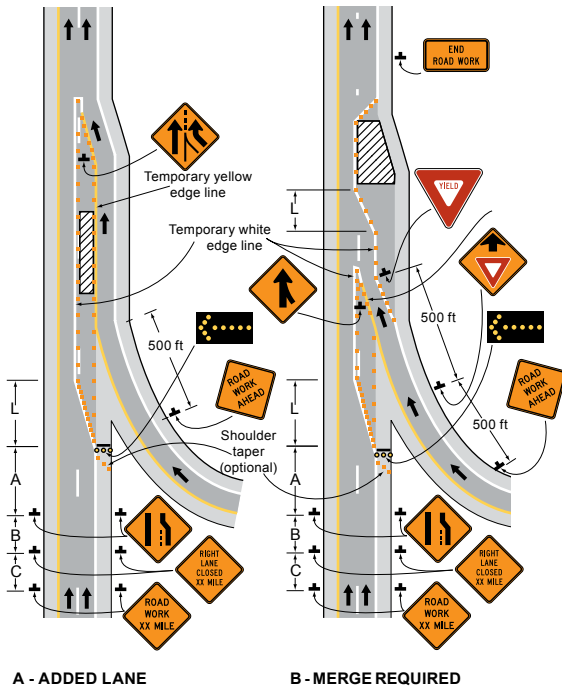

Note: For layout dimensions see page 17.

Work in the Vicinity of a Grade Crossing (TA-46)

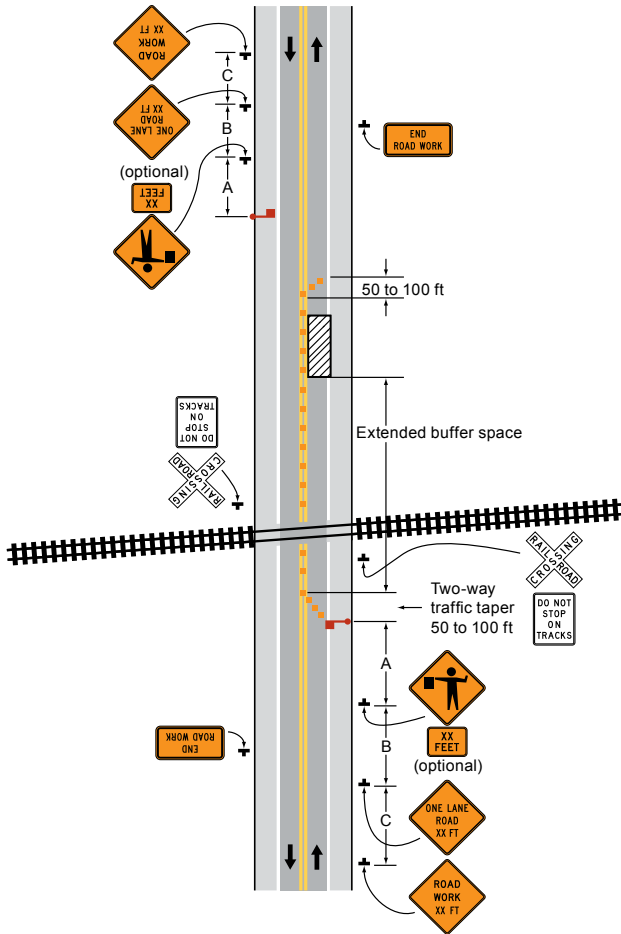

Note: For layout dimensions see page 17.

48

Flagger's Checklist

1. Before heading to the work zone, make sure you have all necessary equipment in working order including: warning signs, flagging paddles, retroreflective clothing, and communication equipment.
2. Place advance warning sign at the appropriate locations as shown in the table on page 17.
 - Signs should always be placed in the following order from farthest from the work zone to closest: ROAD WORK AHEAD, ONE LANE ROAD AHEAD, and the flagger symbol sign.
 - Do not begin the flagging operation until all signs are in place.
3. Always stand alone in a highly visible location when flagging, allowing for space to stop motorists and also warn workers in case of a runaway vehicle.
4. Never stand in the path of traffic.
 - Flagger may step out near the centerline after road users have stopped in order to be visible to other approaching vehicles.
5. Do not leave warning signs after the flagging operation has been terminated.

Supervisor's Checklist

1. Follow Part 6 of the OMUTCD. It is Ohio's standard for work zone traffic control.
2. Have a plan before going to the work site.
3. Remove the devices in a timely manner.
4. Ask yourself, "What is the driver's view of the work site – at night, during peak hours, etc.?"
5. Ask yourself, "Would I feel safe driving through this work zone?"
6. Investigate crashes/incidents to identify if changes are needed in the traffic control plan.
 - Take photographs of all traffic control devices.
 - Sketch and dimension all devices
 - Indicate size of signs, placement from the edge of the travelway, and the height to the bottom of the sign.

The OMUTCD (www.dot.state.oh.us) is the final authority. For all questions contact the ODOT Office of Traffic Engineering at 614-466-3601.

Suggested Traffic Control for Work Zone Activities

1. The matrix on pages 52-53 shows the suggested Temporary Traffic Control for various work activities.
2. A listing of common work activities is provided along with the Temporary Traffic Control layouts (Typical Applications) that may be considered.
3. No situation will exactly match those provided in the Typical Applications. Use common sense to determine which layout best matches your situation.
4. Recommended method for using the matrix:
 - Determine the work activity and find it, or an activity similar to it, in the matrix.
 - Determine the location of the work activity. The location of the work affects the type of Typical Application (TA) used.
 - Determine duration of the activity. Again, the duration of work affects the type of TA that can be used.
 - Review all suggested Typical Applications to see which best fits the operation.
5. Refer to OMUTCD Part 6 for full descriptions of the TA's included here, as well as information on additional TA's available.

Suggested Temporary Traffic Control For Work Activities

Work Activities	TA-1 pg. 19	TA-3 pg. 20	TA-4 pg. 21	TA-6 pg. 22	TA-8 pg. 23	TA-9 pg. 24	TA-10 pg. 26	TA-11 pg. 27	TA-17 pg. 30	TA-20 pg. 32
Mowing	X			X					X	
Pothole Patching							X	X		
Pavement Marking/ Striping							X	X	X	
Road Closings					X	X				X
Road Grading							X	X	X	
Sign Installation/ Repair	X			X						
Tree Removal	X			X			X			
Trenching	X	X		X			X			X

Suggested Temporary Traffic Control For Work Activities

Work Activities	TA-1 pg. 19	TA-3 pg. 20	TA-4 pg. 21	TA-6 pg. 22	TA-8 pg. 23	TA-9 pg. 24	TA-10 pg. 26	TA-13 pg. 28	TA-17 pg. 30	TA-20 pg. 32
Animal Clearance	X		X				X	X		
Berming							X		X	
Bridge Repair					X	X	X			X
Chip Seal Operation			X				X		X	
Chipping		X	X	X			X		X	
Culvert Repair/ Installation					X	X	X			X
Ditching							X		X	
Grader Patching							X		X	
Guardrail Installation/Repair		X		X			X			

Ohio Department of Transportation

Office of Traffic Engineering

1980 West Broad St.

Columbus, OH 43223

Phone: 614-466-3601

www.dot.state.oh.us